

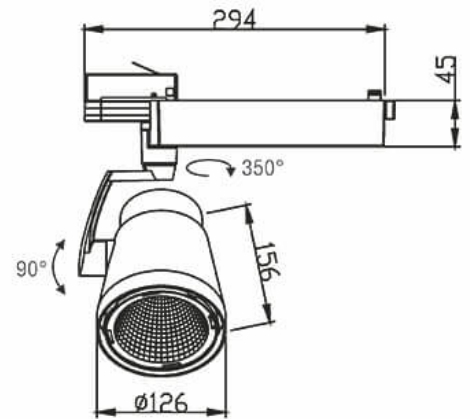

LED track light

PS-TL19-30W

Reflector



Technical Parameters

Name	Parameters
Light source:	COB
Input Voltage:	AC220~240V 50/60Hz
LED Current:	700mA, 35-37V
Rated life:	>50,000 hours
Operating temperature:	-20°-40°
Storage temperature:	-30°-60°
Certificate:	TUV/CE/RoHS
Weight:	2.0KG
Warranty	5 Years



Ordering Information

○ White ● Black

Power	CRI	Beam Angle	Luminous	CCT	Housing	Part Number
30W	>80	▲12°	2830 lm	3000K	○	PS-TL194-30W-830-W-12
					●	PS-TL194-30W-830-B-12
			3030 lm	4000K	○	PS-TL194-30W-840-W-12
					●	PS-TL194-30W-840-B-12
		▲20°	2860 lm	3000K	○	PS-TL194-30W-830-W-20
					●	PS-TL194-30W-830-B-20
			3050 lm	4000K	○	PS-TL194-30W-840-W-20
					●	PS-TL194-30W-840-B-20
		▲45°	2740 lm	3000K	○	PS-TL194-30W-830-W-45
					●	PS-TL194-30W-830-B-45
			2920 lm	4000K	○	PS-TL194-30W-840-W-45
					●	PS-TL194-30W-840-B-45
	>90	▲12°	2590 lm	3000K	○	PS-TL194-30W-930-W-12
					●	PS-TL194-30W-930-B-12
			2690 lm	4000K	○	PS-TL194-30W-940-W-12
					●	PS-TL194-30W-940-B-12
		▲20°	2600 lm	3000K	○	PS-TL194-30W-930-W-20
					●	PS-TL194-30W-930-B-20
			2720 lm	4000K	○	PS-TL194-30W-940-W-20
					●	PS-TL194-30W-940-B-20
		▲45°	2480 lm	3000K	○	PS-TL194-30W-930-W-45
					●	PS-TL194-30W-930-B-45
			2600 lm	4000K		PS-TL194-30W-940-W-45
					●	PS-TL194-30W-940-B-45



Technical Data test pattern

CRI80 12°

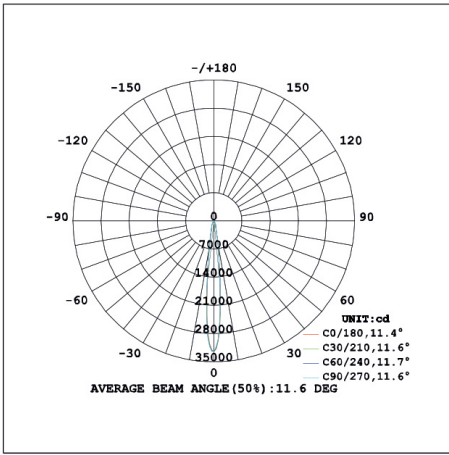

3000K

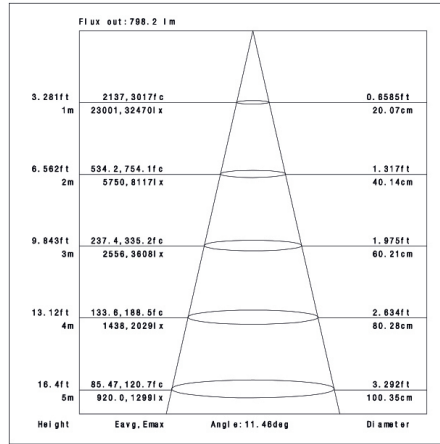

4000K

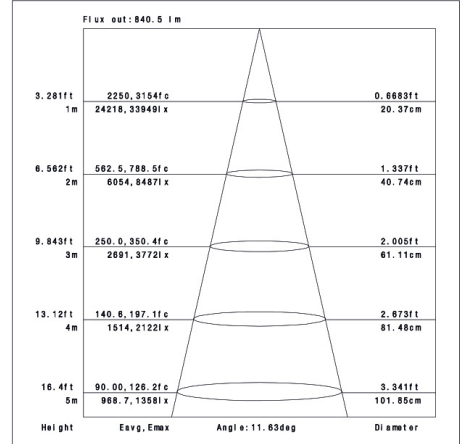

CRI80 20°

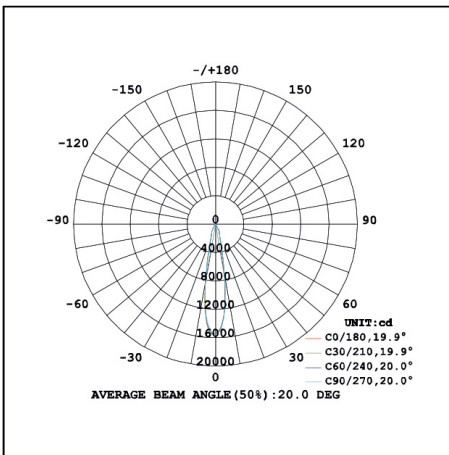

3000K

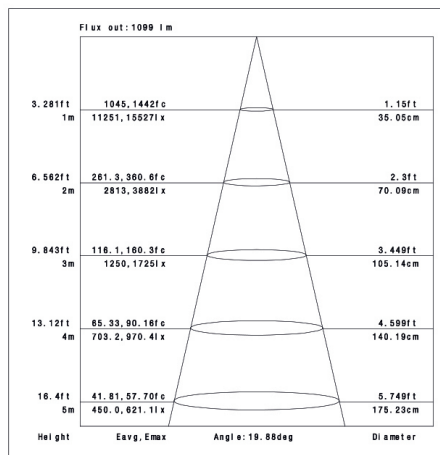

4000K

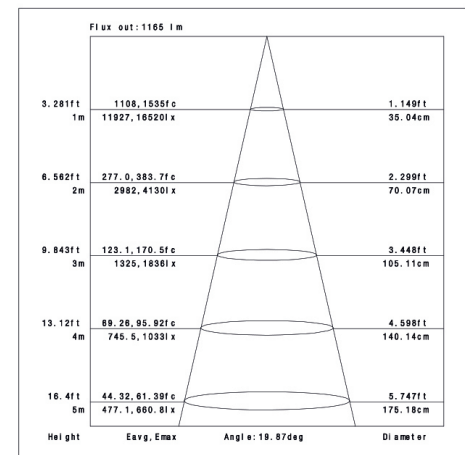

CRI80 45°

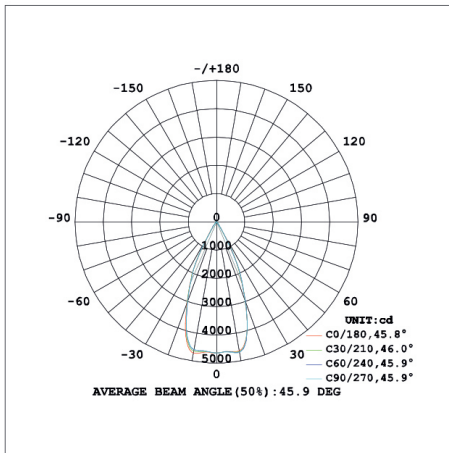

3000K

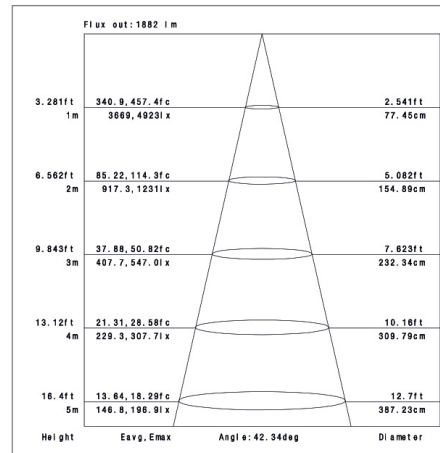

4000K

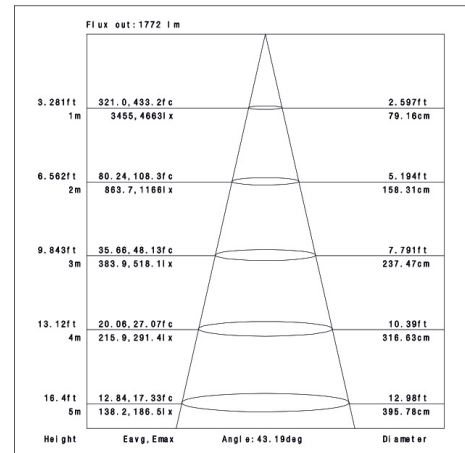



CRI90 12°

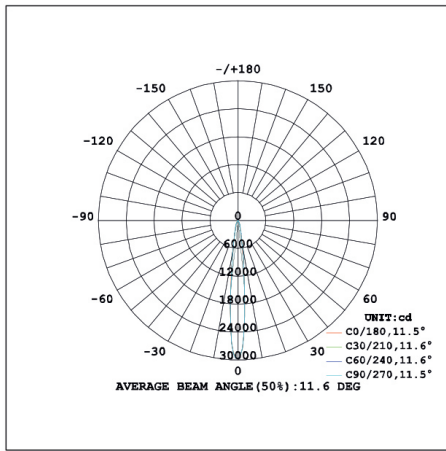

3000K

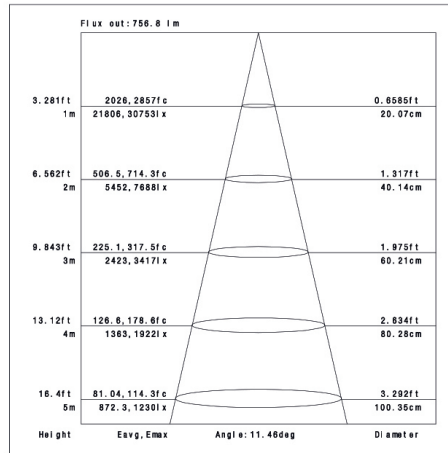

4000K

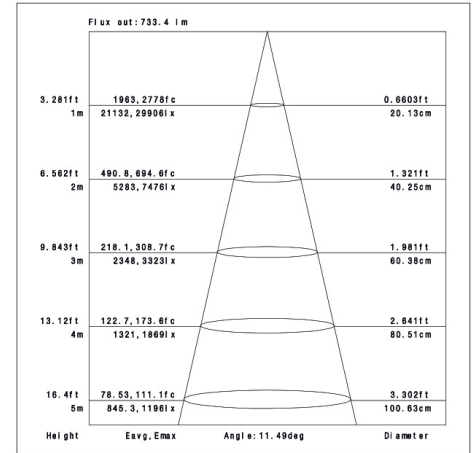

CRI90 20°

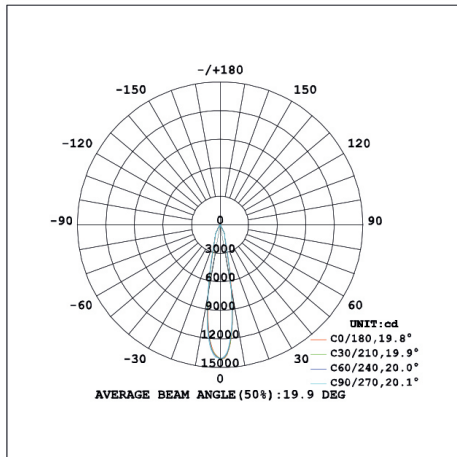

3000K

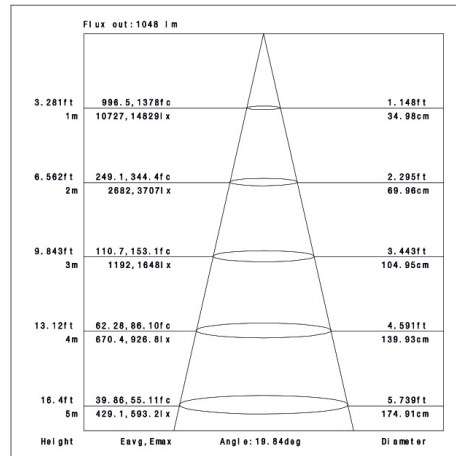

4000K

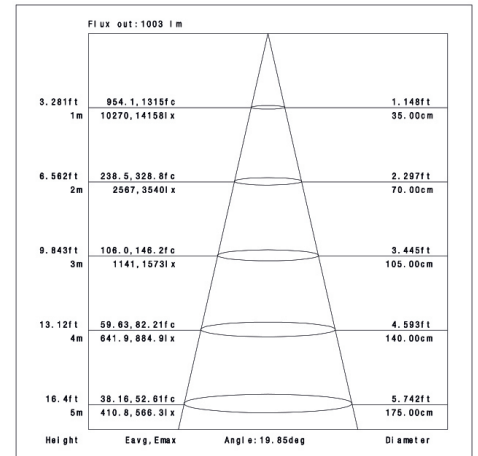

CRI90 45°

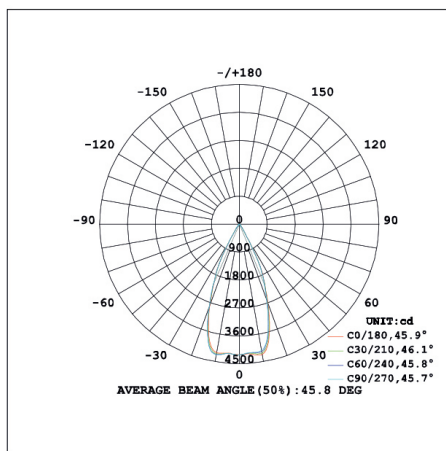

3000K

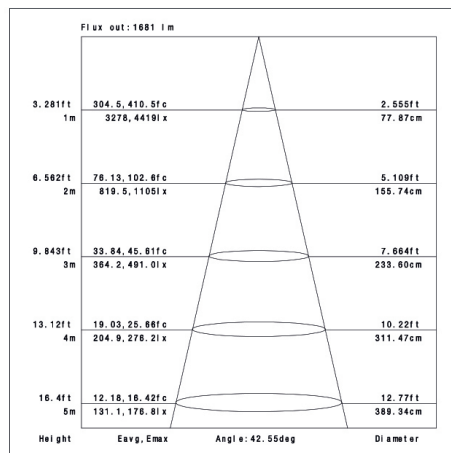

4000K

