



LED Street Light

PS-ST07



Product Description

LED streetlight is low-profile, durable and equipped with state-of-the-art fixtures. Designed for roadway and parking lot areas, to replace traditional street and parking areas lights with quick payback and superior lighting performance.

Features

- Super Smooth Surface
- Tool-free Opening and Maintenance
- Easy Replacement for LED Driver
- Power-off Protection
- Surge Protection
- Wide choice of optics and installation spigots

Application

- Traffic roads
- Residential areas
- Plazas, parking lots

Dimensions

Standard

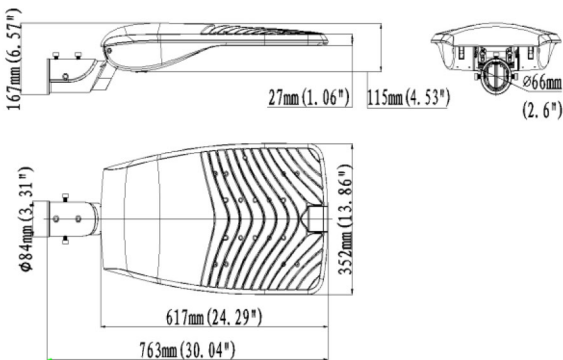

With Photocell

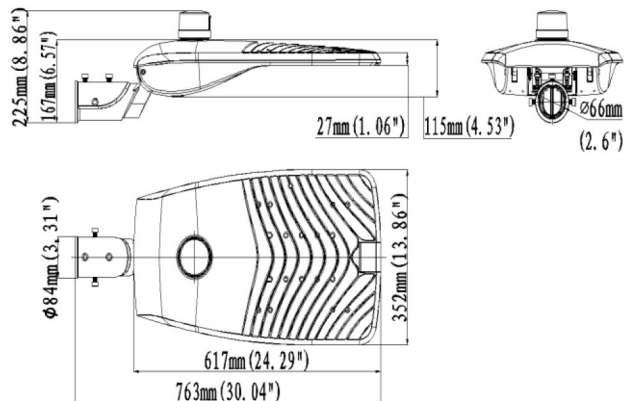



Specifications

Model No.	PS-ST07-030	PS-ST07-050	PS-ST07-070	PS-ST07-090	PS-ST07-120	PS-ST07-150	PS-ST07-180
Power Consumption	30±3W	50±3W	70±3W	90±4W	120±6W	150±7W	180±9W
LED Type	Nichia LED						
Luminous Flux (±5%)	3900lm	6500lm	9100lm	11700lm	15600lm	18750lm	21600lm
Efficacy ±5% @4000K	130lm/W					125lm/W	120lm/W
Color Temperature	4.000K (3.000K, 5.000K optional)						
Color Rendering Index	Ra70 (Ra80 optional)						
Beam Angle	R17601, R17602, R17603, R17604, R17605						
Power Supply	SOSEN						
Input Voltage	100-240 VAC / 100-277 VAC						
Power Factor	>0.90			≥0.92			
Frequency	50 / 60 Hz						
Surge Protection	6kV line-line, 10kV line-earth						
Driver Type	Constant Current (CC)						
Product Dimension	680x282x160mm			763x352x167mm			
Luminaire Net Weight	8.5±0.3kg (18.74 ±0.66Lbs)	8.8±0.3kg (19.4±0.66Lbs)		9.0±0.3kg (19.84 ±0.66Lbs)	9.2±0.3kg (20.28±0.66Lbs)		
Export Carton Size	695x420x275mm(27.36".16.54".10.83")						
Gross Weight	10.2±0.3kg (22.44 ±0.66Lbs)	10.5±0.3kg (23.1 ±0.66Lbs)		10.7±0.3kg (23.54 ±0.66Lbs)	10.9±0.3kg (23.98±0.66Lbs)		
Material Housing	Aluminum Alloy						
Material Optics	Polycarbonate Optical Lens+Tempered Glass						
Finish	Powder Coating						
Fixture Color	Grey						
IP Rating	IP66						
Mounting Option	Pole Mounting (Adjustable Angle)/Wall mounting						
Operating Temperature	-30°C to + 50°C(-22°F to 122°F)						
Life Time	>50,000Hrs (Ta=30°C@L70)						
Warranty	5 Years						
Dimmable	Dimmable and Non-dimmable						
Intelligent Control	Photocell Control/DALI Control /Timing Control						
Accessory	Spigot- φ34mm/42mm/60mm/72mm Wall mount bracket NEMA Socket - 3pin/5pin/7pin Photocell controller Short Cap						



Photometry

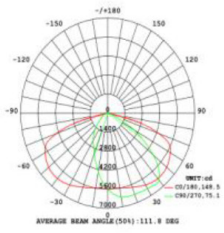

R17601

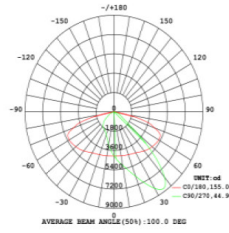

R17602

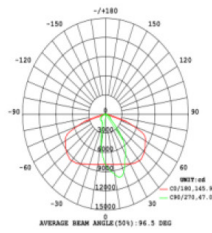

R17603

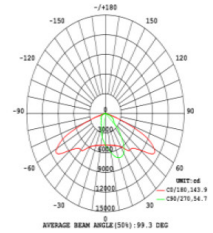

R17604

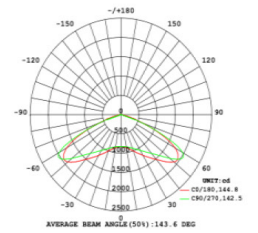

R17605

Mounting Options

Horizontal



Vertic



Wall mount



(Adjustable Angle)

